

NOTE:

CENTER PIN GOLD PLATING 3μ THICK OVER NICKEL PLATING 70μ
 THICK OVER NICKEL STRIKE
 BODY GOLD PLATING 1.5μ THICK OVER NICKEL PLATING 80μ THICK
 OVER NICKEL STRIKE
 BRASS AND PTFE PER SGS
 FINISH PLATING THICKNESS IN MICRO-INCHES
 COPPER PARTS AUTOMATIC CNC MANUFACTURING

Prohibit re-circulating



	華耀科技有限公司 <i>Hwa Yao Technologies co.,Ltd</i>
	TITLE MMCX MALE CRIMP
	DRAWING NO. MMCX-801

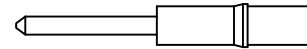
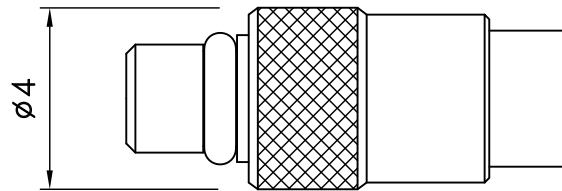

NOTE:

CENTER PIN GOLD PLATING 3 μ THICK OVER NICKEL PLATING 70 μ
 THICK OVER NICKEL STRIKE
 BODY GOLD PLATING 1.5 μ THICK OVER NICKEL PLATING 80 μ THICK
 OVER NICKEL STRIKE
 BRASS AND PTFE PER SGS
 FINISH PLATING THICKNESS IN MICRO-INCHES
 COPPER PARTS AUTOMATIC CNC MANUFACTURING

Prohibit re-circulating



	華耀科技有限公司 Hwa Yao Technologies co.,Ltd
TITLE MMCX MALE SOLDER	
DRAWING NO. MMCX-801	

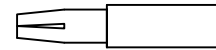
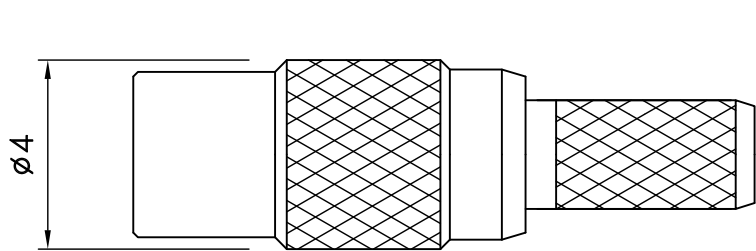

NOTE:

CENTER PIN GOLD PLATING 1μ THICK OVER NICKEL PLATING 70μ
 THICK OVER NICKEL STRIKE
 BODY GOLD PLATING 1μ THICK OVER NICKEL PLATING 80μ THICK
 OVER NICKEL STRIKE
 BRASS AND PTFE PER SGS
 FINISH PLATING THICKNESS IN MICRO-INCHES
 COPPER PARTS AUTOMATIC CNC MANUFACTURING

Prohibit re-circulating



華耀科技有限公司
 Hwa Yao Technologies co.,Ltd

TITLE
 MMCX FEMALE CRIMP
 DRAWING NO.
 MMCX-820

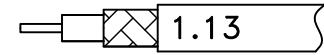
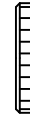
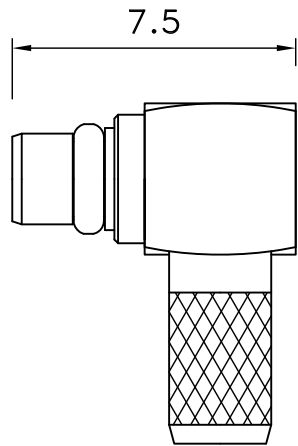

NOTE:

CENTER PIN GOLD PLATING 1μ THICK OVER NICKEL PLATING 70μ
 THICK OVER NICKEL STRIKE
 BODY GOLD PLATING 1μ THICK OVER NICKEL PLATING 80μ THICK
 OVER NICKEL STRIKE
 BRASS AND PTFE PER SGS
 FINISH PLATING THICKNESS IN MICRO-INCHES
 COPPER PARTS AUTOMATIC CNC MANUFACTURING

Prohibit re-circulating



華耀科技有限公司
 Hwa Yao Technologies co.,Ltd

TITLE	MMCX MALE RIGHT ANGLE CRIMP
DRAWING NO.	MMCX-802

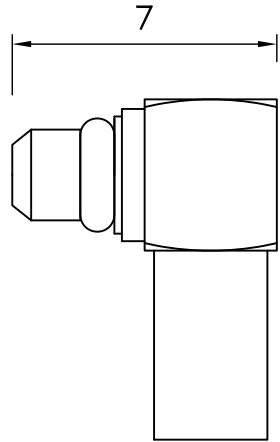

NOTE:

CENTER PIN GOLD PLATING 1μ THICK OVER NICKEL PLATING 70μ
THICK OVER NICKEL STRIKE
BODY GOLD PLATING 1μ THICK OVER NICKEL PLATING 80μ THICK
OVER NICKEL STRIKE
BRASS AND PTFE PER SGS
FINISH PLATING THICKNESS IN MICRO-INCHES
COPPER PARTS AUTOMATIC CNC MANUFACTURING

Prohibit re-circulating



華耀科技有限公司
Hwa Yao Technologies co.,Ltd

TITLE
MMCX MALE RIGHT ANGLE SOLDER
DRAWING NO.
MMCX-802

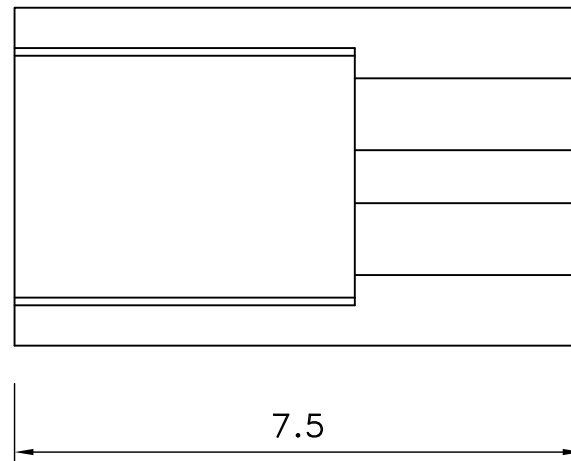
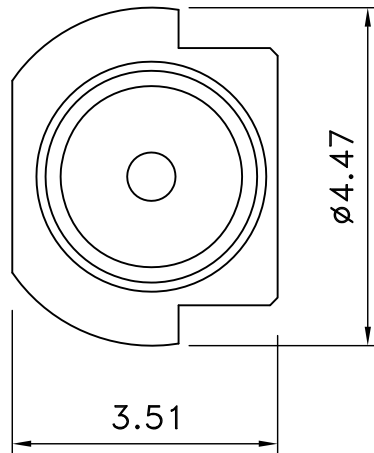

NOTE:

CENTER PIN GOLD PLATING 1 μ THICK OVER NICKEL PLATING 70 μ
 THICK OVER NICKEL STRIKE
 BODY GOLD PLATING 1 μ THICK OVER NICKEL PLATING 80 μ THICK
 OVER NICKEL STRIKE
 BRASS AND PTFE PER SGS
 FINISH PLATING THICKNESS IN MICRO-INCHES
 COPPER PARTS AUTOMATIC CNC MANUFACTURING

Prohibit re-circulating



	華耀科技有限公司 Hwa Yao Technologies co.,Ltd
TITLE MMCX FEMALE PCB MOUNT	
DRAWING NO. MMCX-805	