

NOTE:

CENTER PIN GOLD PLATING 20 μ THICK OVER NICKEL PLATING 70 μ
 THICK OVER NICKEL STRIKE
 BODY GOLD PLATING 3 μ THICK OVER NICKEL PLATING 80 μ THICK
 OVER NICKEL STRIKE
 BRASS AND PTFE PER SGS
 FINISH PLATING THICKNESS IN MICRO-INCHES
 COPPER PARTS AUTOMATIC CNC MANUFACTURING

Prohibit re-circulating



華耀科技有限公司
 Hwa Yao Technologies co.,Ltd

TITLE
 SMA MALE CRIMP
 DRAWING NO.
 SMA-1001

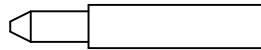
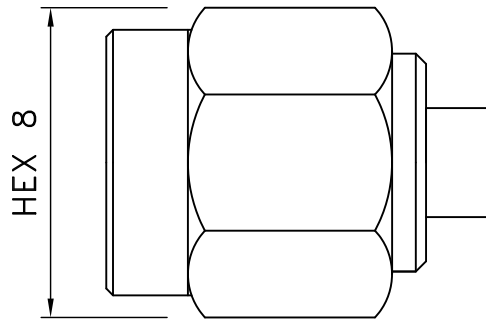

NOTE:

CENTER PIN GOLD PLATING 20 μ THICK OVER NICKEL PLATING 70 μ
 THICK OVER NICKEL STRIKE
 BODY GOLD PLATING 3 μ THICK OVER NICKEL PLATING 80 μ THICK
 OVER NICKEL STRIKE
 BRASS AND PTFE PER SGS
 FINISH PLATING THICKNESS IN MICRO-INCHES
 COPPER PARTS AUTOMATIC CNC MANUFACTURING

Prohibit re-circulating



華耀科技有限公司
 Hwa Yao Technologies co.,Ltd

TITLE
 SMA MALE SOLDER
 DRAWING NO.
 SMA-1001

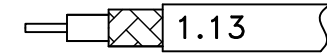
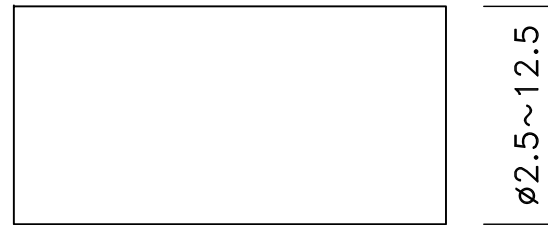
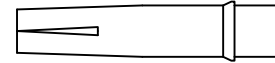
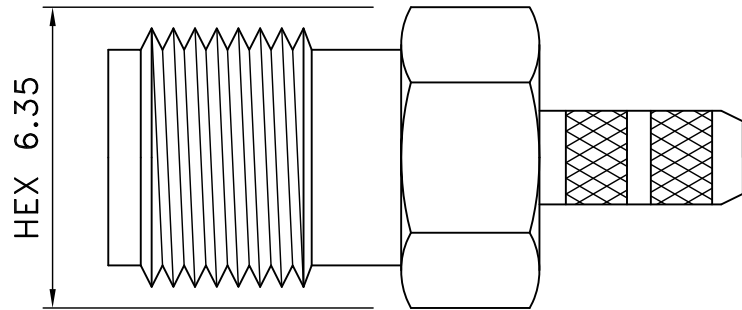

NOTE:

CENTER PIN GOLD PLATING 20 μ THICK OVER NICKEL PLATING 70 μ
 THICK OVER NICKEL STRIKE
 BODY GOLD PLATING 3 μ THICK OVER NICKEL PLATING 80 μ THICK
 OVER NICKEL STRIKE
 BRASS AND PTFE PER SGS
 FINISH PLATING THICKNESS IN MICRO-INCHES
 COPPER PARTS AUTOMATIC CNC MANUFACTURING

Prohibit re-circulating



華耀科技有限公司
 Hwa Yao Technologies co.,Ltd

TITLE
 SMA FEMALE CRIMP
 DRAWING NO.
 SMA-1011

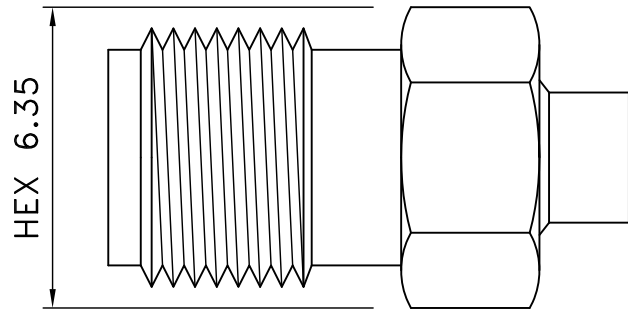

NOTE:

CENTER PIN GOLD PLATING 20 μ THICK OVER NICKEL PLATING 70 μ
 THICK OVER NICKEL STRIKE
 BODY GOLD PLATING 3 μ THICK OVER NICKEL PLATING 80 μ THICK
 OVER NICKEL STRIKE
 BRASS AND PTFE PER SGS
 FINISH PLATING THICKNESS IN MICRO-INCHES
 COPPER PARTS AUTOMATIC CNC MANUFACTURING

Prohibit re-circulating



	華耀科技有限公司 Hwa Yao Technologies co.,Ltd
TITLE	SMA FEMALE SOLDER
DRAWING NO.	SMA-1011

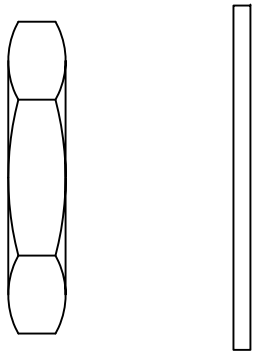
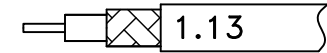
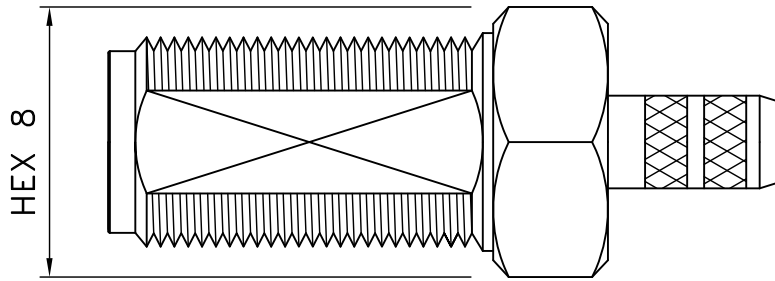

NOTE:

CENTER PIN GOLD PLATING 20μ THICK OVER NICKEL PLATING 70μ
 THICK OVER NICKEL STRIKE
 BODY GOLD PLATING 3μ THICK OVER NICKEL PLATING 80μ THICK
 OVER NICKEL STRIKE
 BRASS AND PTFE PER SGS
 FINISH PLATING THICKNESS IN MICRO-INCHES
 COPPER PARTS AUTOMATIC CNC MANUFACTURING

Prohibit re-circulating



華耀科技有限公司
 Hwa Yao Technologies co.,Ltd

TITLE
 SMA FEMALE BULKHEAD CRIMP
 DRAWING NO.
 SMA-1012

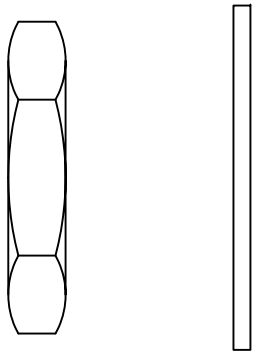
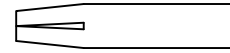
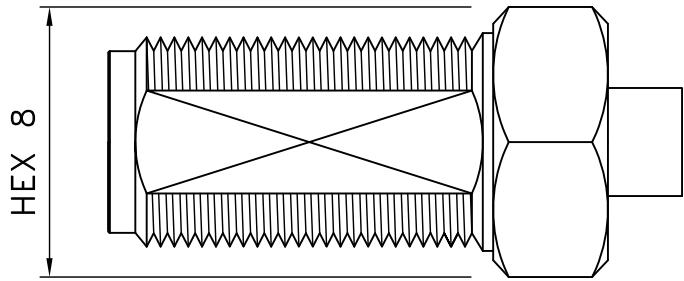

NOTE:

CENTER PIN GOLD PLATING 20 μ THICK OVER NICKEL PLATING 70 μ
 THICK OVER NICKEL STRIKE
 BODY GOLD PLATING 3 μ THICK OVER NICKEL PLATING 80 μ THICK
 OVER NICKEL STRIKE
 BRASS AND PTFE PER SGS
 FINISH PLATING THICKNESS IN MICRO-INCHES
 COPPER PARTS AUTOMATIC CNC MANUFACTURING

Prohibit re-circulating



華耀科技有限公司
 Hwa Yao Technologies co.,Ltd

TITLE	SMA FEMALE BULKHEAD SOLDER
DRAWING NO.	SMA-1012

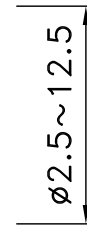
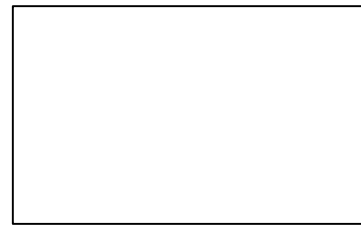
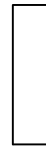
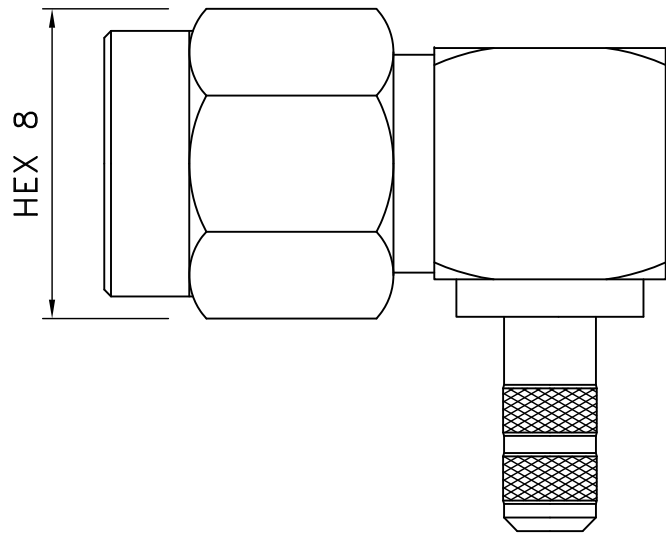

NOTE:

CENTER PIN GOLD PLATING 20 μ THICK OVER NICKEL PLATING 70 μ
 THICK OVER NICKEL STRIKE
 BODY GOLD PLATING 3 μ THICK OVER NICKEL PLATING 80 μ THICK
 OVER NICKEL STRIKE
 BRASS AND PTFE PER SGS
 FINISH PLATING THICKNESS IN MICRO-INCHES
 COPPER PARTS AUTOMATIC CNC MANUFACTURING

Prohibit re-circulating



華耀科技有限公司
 Hwa Yao Technologies co.,Ltd

TITLE
 SMA MALE RIGHT ANGLE CRIMP
 DRAWING NO.
 SMA-1002

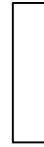
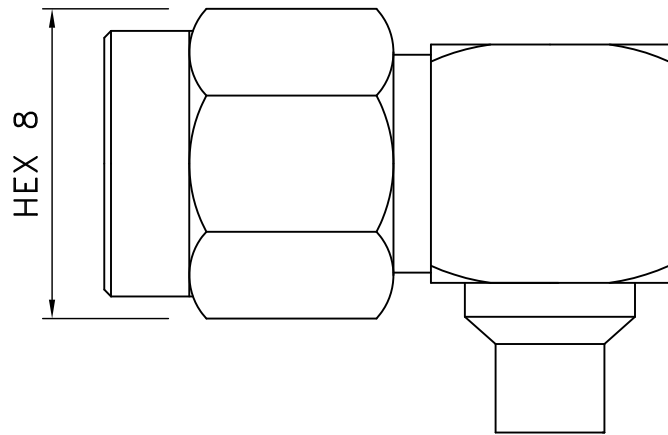

NOTE:

CENTER PIN GOLD PLATING 20 μ THICK OVER NICKEL PLATING 70 μ
 THICK OVER NICKEL STRIKE
 BODY GOLD PLATING 3 μ THICK OVER NICKEL PLATING 80 μ THICK
 OVER NICKEL STRIKE
 BRASS AND PTFE PER SGS
 FINISH PLATING THICKNESS IN MICRO-INCHES
 COPPER PARTS AUTOMATIC CNC MANUFACTURING

Prohibit re-circulating



華耀科技有限公司
 Hwa Yao Technologies co.,Ltd

TITLE	SMA MALE RIGHT ANGLE SOLDER
DRAWING NO.	SMA-1012

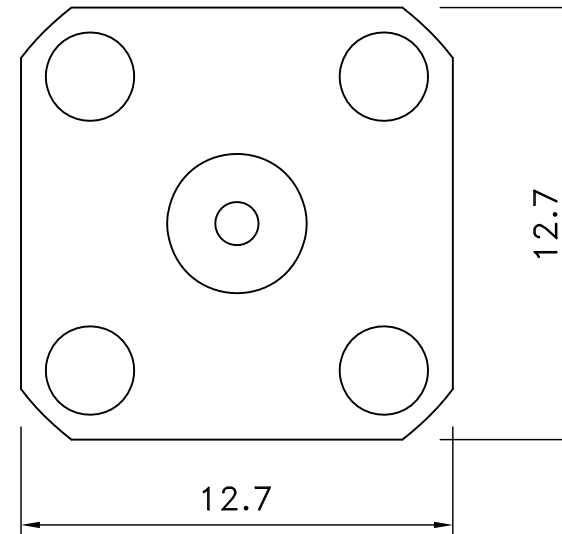
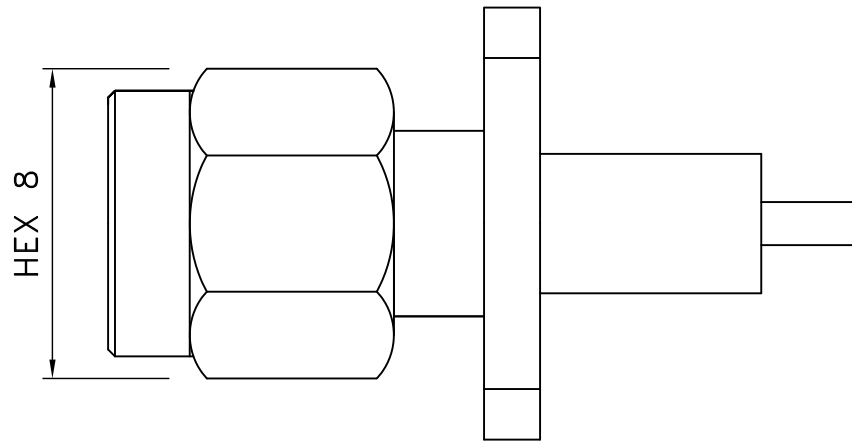

NOTE:

CENTER PIN GOLD PLATING 20 μ THICK OVER NICKEL PLATING 70 μ
 THICK OVER NICKEL STRIKE
 BODY GOLD PLATING 3 μ THICK OVER NICKEL PLATING 80 μ THICK
 OVER NICKEL STRIKE
 BRASS AND PTFE PER SGS
 FINISH PLATING THICKNESS IN MICRO-INCHES
 COPPER PARTS AUTOMATIC CNC MANUFACTURING

Prohibit re-circulating



	華耀科技有限公司 Hwa Yao Technologies co.,Ltd
TITLE SMA MALE PANEL MOUNT	
DRAWING NO. SMA-1007	

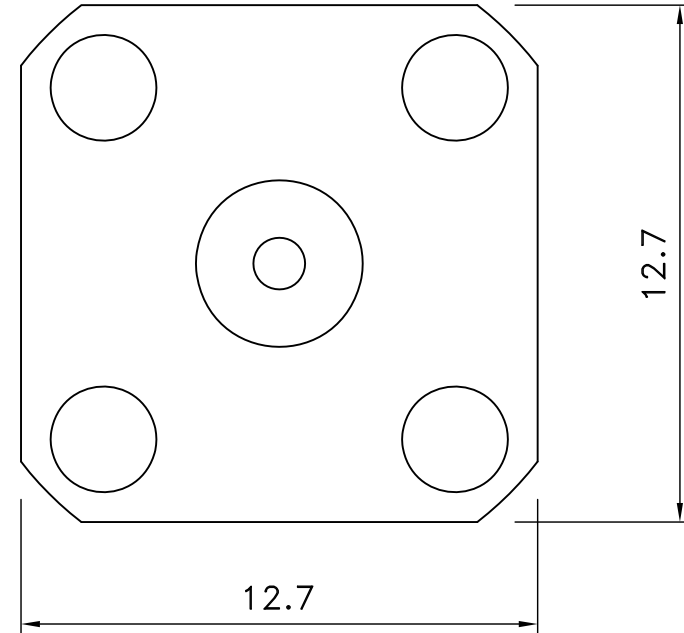
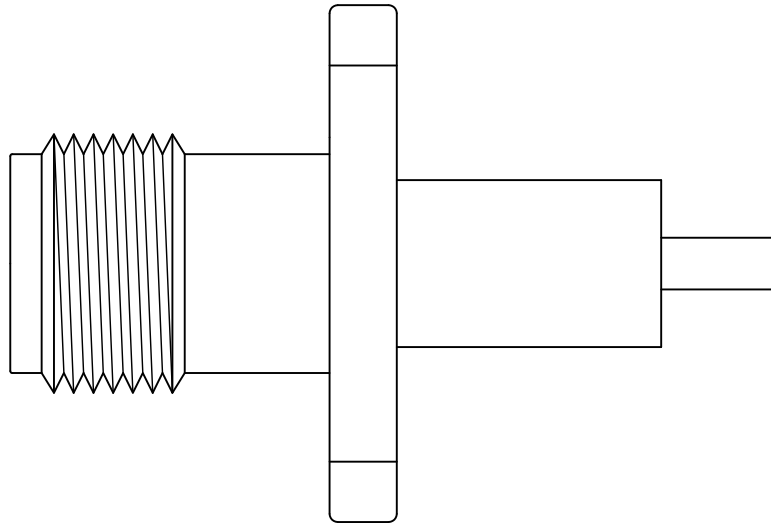

NOTE:

CENTER PIN GOLD PLATING 20 μ THICK OVER NICKEL PLATING 70 μ
 THICK OVER NICKEL STRIKE
 BODY GOLD PLATING 3 μ THICK OVER NICKEL PLATING 80 μ THICK
 OVER NICKEL STRIKE
 BRASS AND PTFE PER SGS
 FINISH PLATING THICKNESS IN MICRO-INCHES
 COPPER PARTS AUTOMATIC CNC MANUFACTURING

Prohibit re-circulating



華耀科技有限公司
 Hwa Yao Technologies co.,Ltd

TITLE
 SMA FEMALE PANEL MOUNT
 DRAWING NO.
 SMA-1020

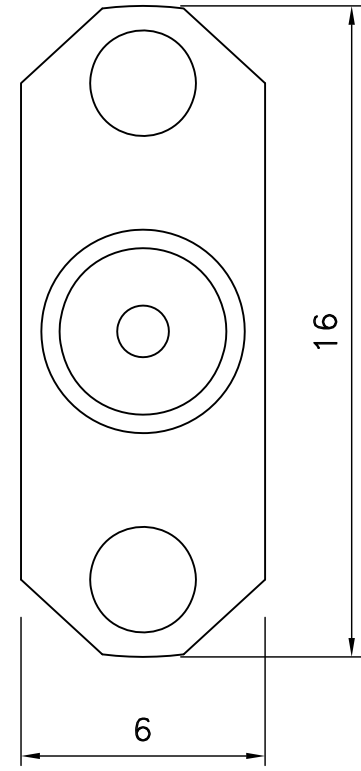
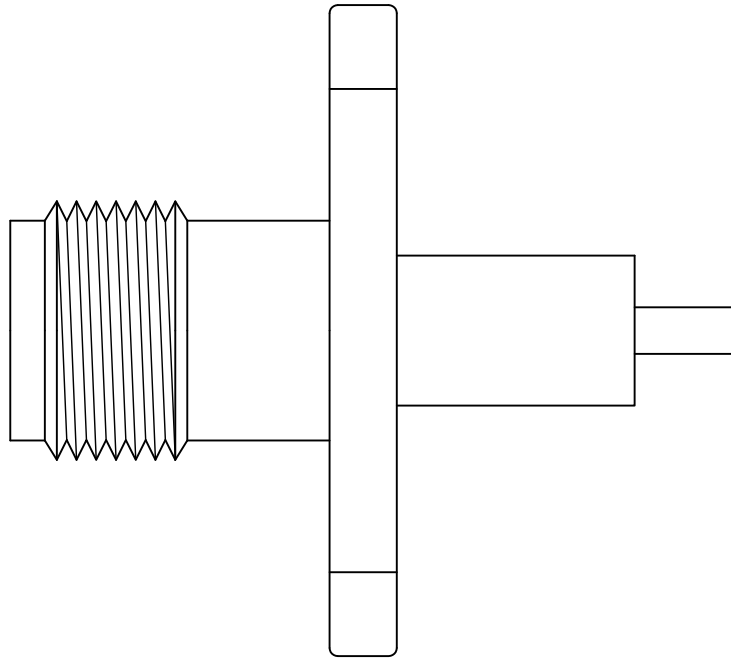

NOTE:

CENTER PIN GOLD PLATING 20 μ THICK OVER NICKEL PLATING 70 μ THICK OVER NICKEL STRIKE
 BODY GOLD PLATING 3 μ THICK OVER NICKEL PLATING 80 μ THICK OVER NICKEL STRIKE
 BRASS AND PTFE PER SGS
 FINISH PLATING THICKNESS IN MICRO-INCHES
 COPPER PARTS AUTOMATIC CNC MANUFACTURING

Prohibit re-circulating



	華耀科技有限公司 <i>Hwa Yao Technologies co.,Ltd</i>
	TITLE SMA FEMALE PANEL MOUNT
	DRAWING NO. SMA-1018

All creative content and details belonging to HYT's confidential, and the owner, without consent, Do not posted, theft, copied and sent to a third party.

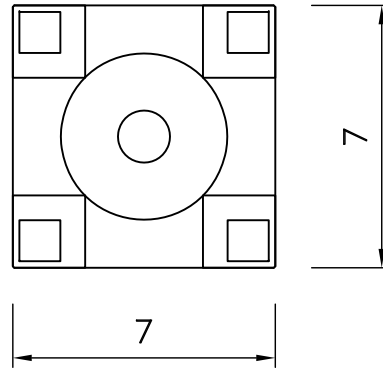
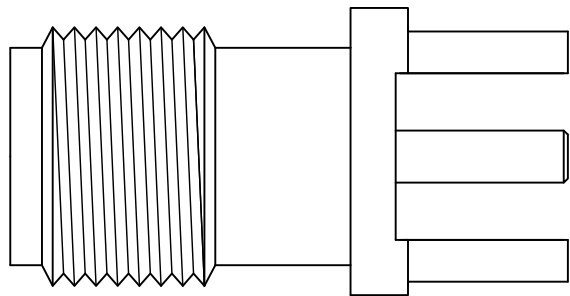

NOTE:

CENTER PIN GOLD PLATING 20 μ THICK OVER NICKEL PLATING 70 μ
THICK OVER NICKEL STRIKE
BODY GOLD PLATING 3 μ THICK OVER NICKEL PLATING 80 μ THICK
OVER NICKEL STRIKE
BRASS AND PTFE PER SGS
FINISH PLATING THICKNESS IN MICRO-INCHES
COPPER PARTS AUTOMATIC CNC MANUFACTURING

Prohibit re-circulating



華耀科技有限公司
Hwa Yao Technologies co.,Ltd

TITLE
SMA FEMALE PANEL MOUNT
DRAWING NO.
SMA-1023

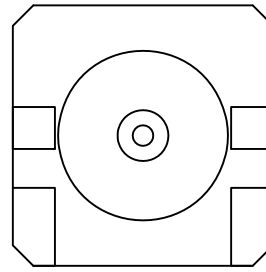
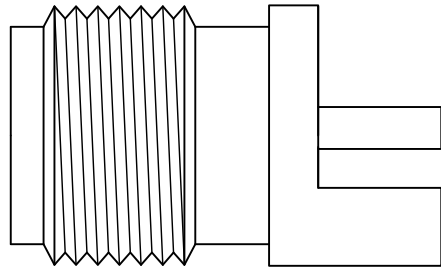

0.8~1.73

NOTE:

CENTER PIN GOLD PLATING 20μ THICK OVER NICKEL PLATING 70μ
THICK OVER NICKEL STRIKE
BODY GOLD PLATING 3μ THICK OVER NICKEL PLATING 80μ THICK
OVER NICKEL STRIKE
BRASS AND PTFE PER SGS
FINISH PLATING THICKNESS IN MICRO-INCHES
COPPER PARTS AUTOMATIC CNC MANUFACTURING

Prohibit re-circulating



華耀科技有限公司
Hwa Yao Technologies co.,Ltd

TITLE
SMA FEMALE PANEL MOUNT
DRAWING NO.
SMA-1024

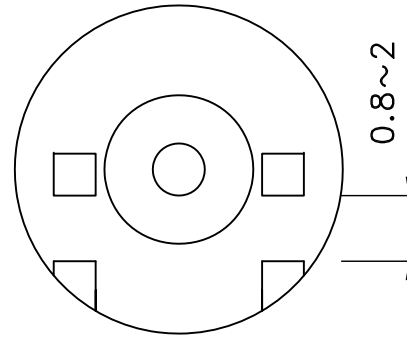
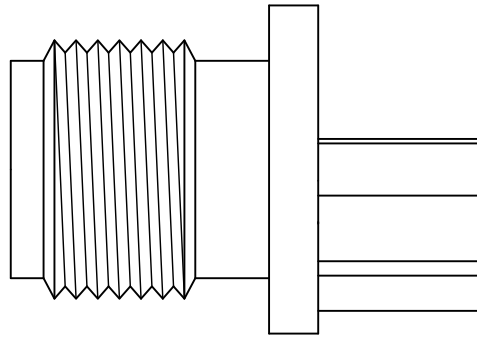

NOTE:

CENTER PIN GOLD PLATING 20μ THICK OVER NICKEL PLATING 70μ
THICK OVER NICKEL STRIKE
BODY GOLD PLATING 3μ THICK OVER NICKEL PLATING 80μ THICK
OVER NICKEL STRIKE
BRASS AND PTFE PER SGS
FINISH PLATING THICKNESS IN MICRO-INCHES
COPPER PARTS AUTOMATIC CNC MANUFACTURING

Prohibit re-circulating



華耀科技有限公司
Hwa Yao Technologies co.,Ltd

TITLE
SMA FEMALE PANEL MOUNT
DRAWING NO.
SMA-1024